

JST-SMR-03V-B

Pin1 -- 棕色/+
Pin2 -- 空 /NC
Pin3 -- 蓝色/-

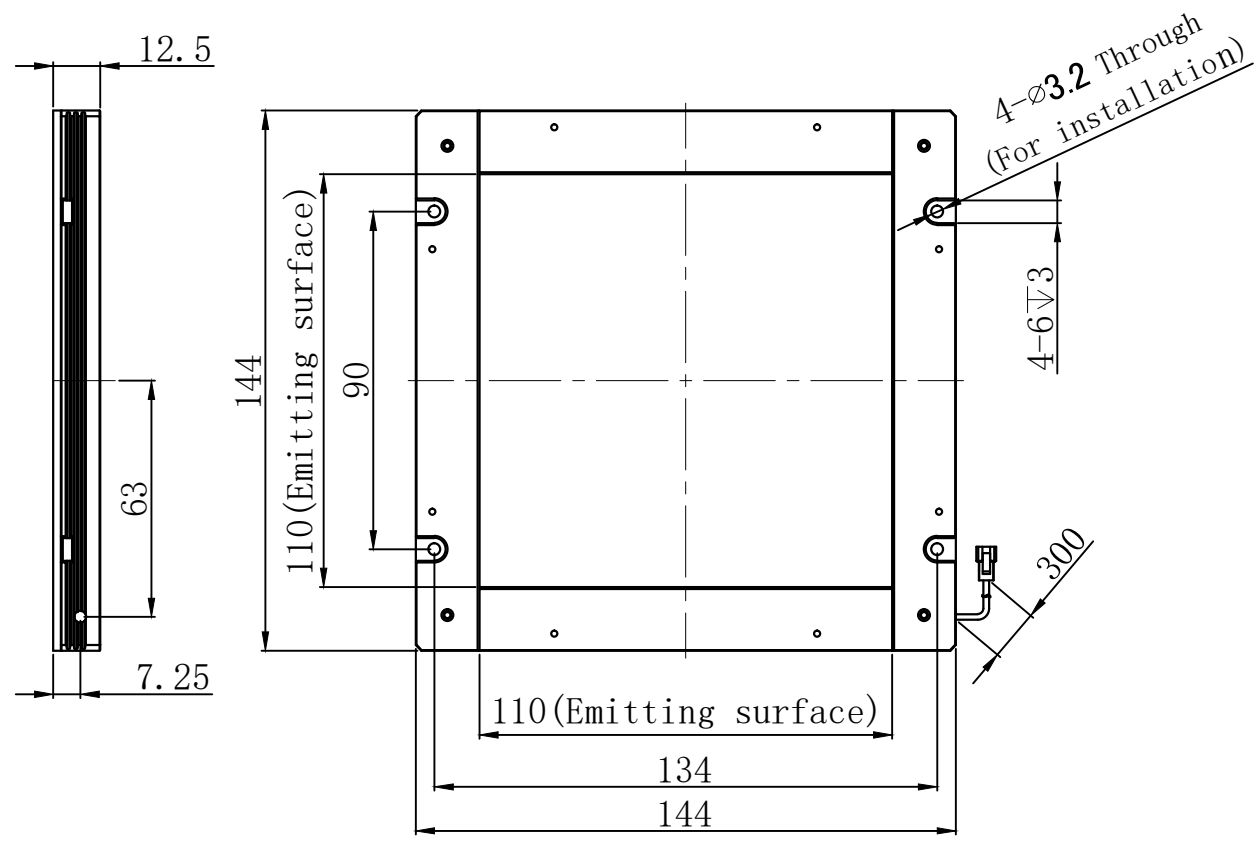

Product Installation Dimensions					Design	成忠波		2017.07.09		wordop® 沃德普	
Input Voltage	Power				Approve						
	R	W/G/B	IR	UV	Weight	View Direction	Ratio	Unit	Name	Side-Irradiation Collimated Backlights	
24V	6.8W	12.6W			470g		1:2	mm	Model	FQGP2-110X110	