

JST-SMR-03V-B
 Pin1 -- 棕色/+
 Pin2 -- 空 /NC
 Pin3 -- 蓝色/-

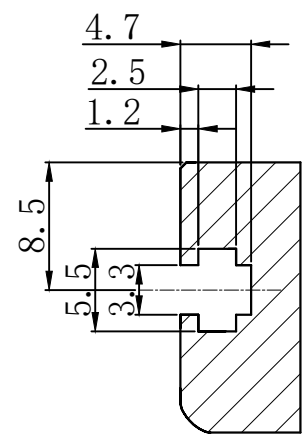
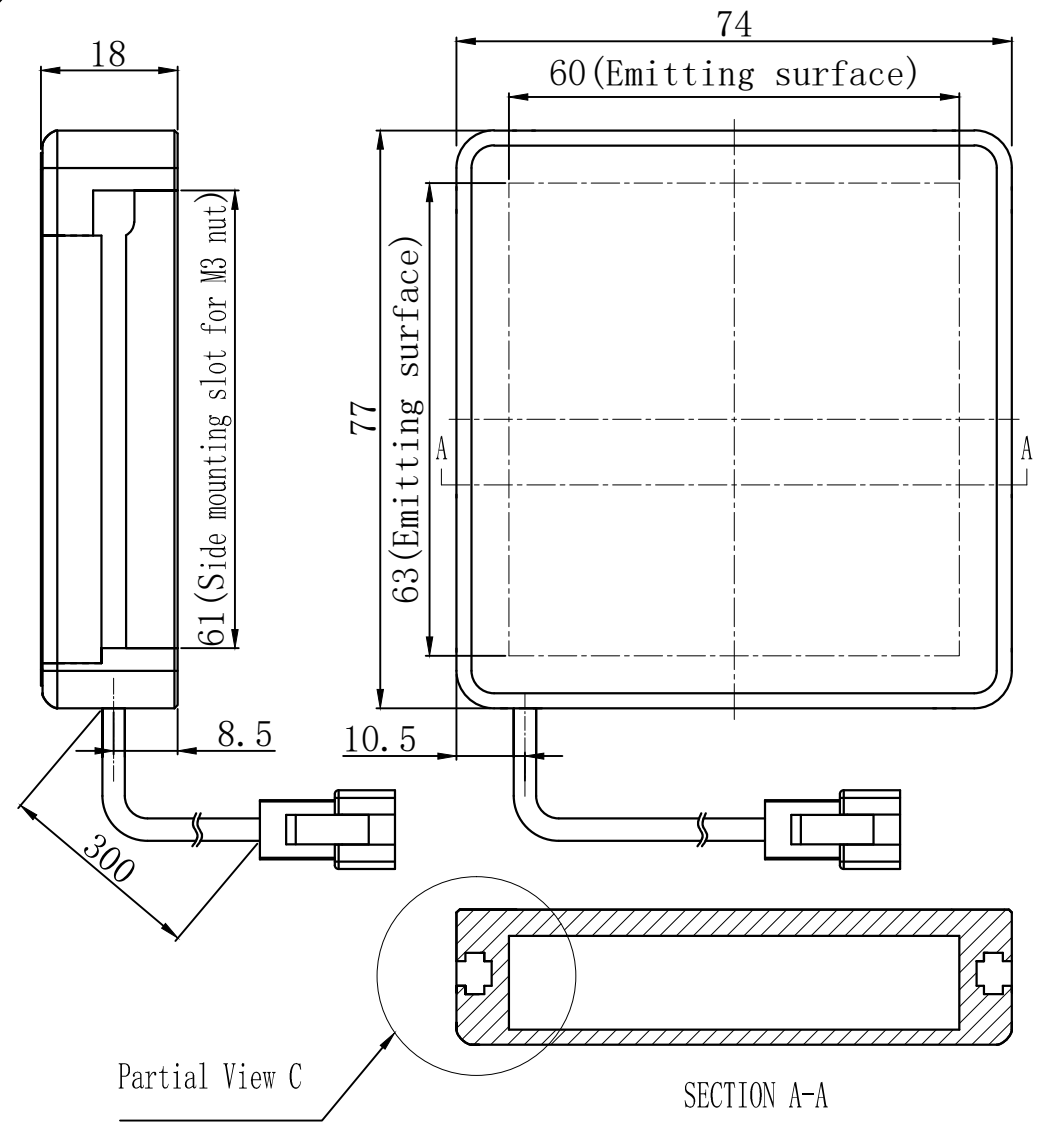
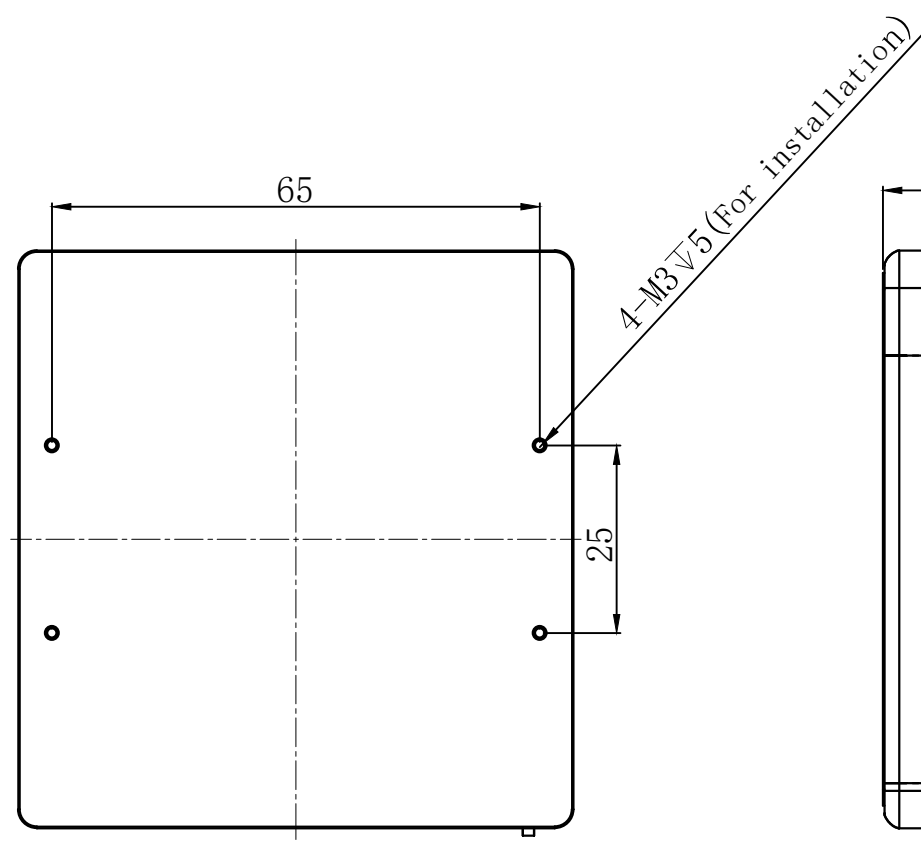

Partial View C , Four sides, Mounting slot for M3 nut, Scale 2:1

Product Installation Dimensions					Design	成忠波		2017.07.09		wordop® 沃德普	
Input Voltage	Power				Approve				Name		
	R	W/G/B	IR	UV	Weight	View Direction	Ratio	Unit	Model	FQ2-63X60	
24V	4.1W	5.1W			130g		1:1	mm			