

JST-SMR-03V-B

Pin1 -- 棕色/+
Pin2 -- 空 /NC
Pin3 -- 蓝色/-

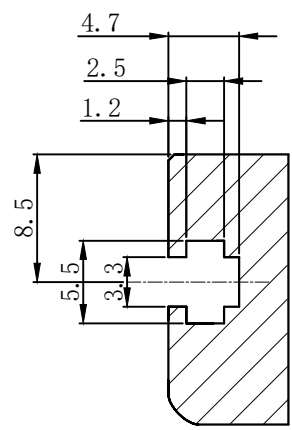

Partial View C , Four sides, Mounting slot for M3 nut, Scale 4:1

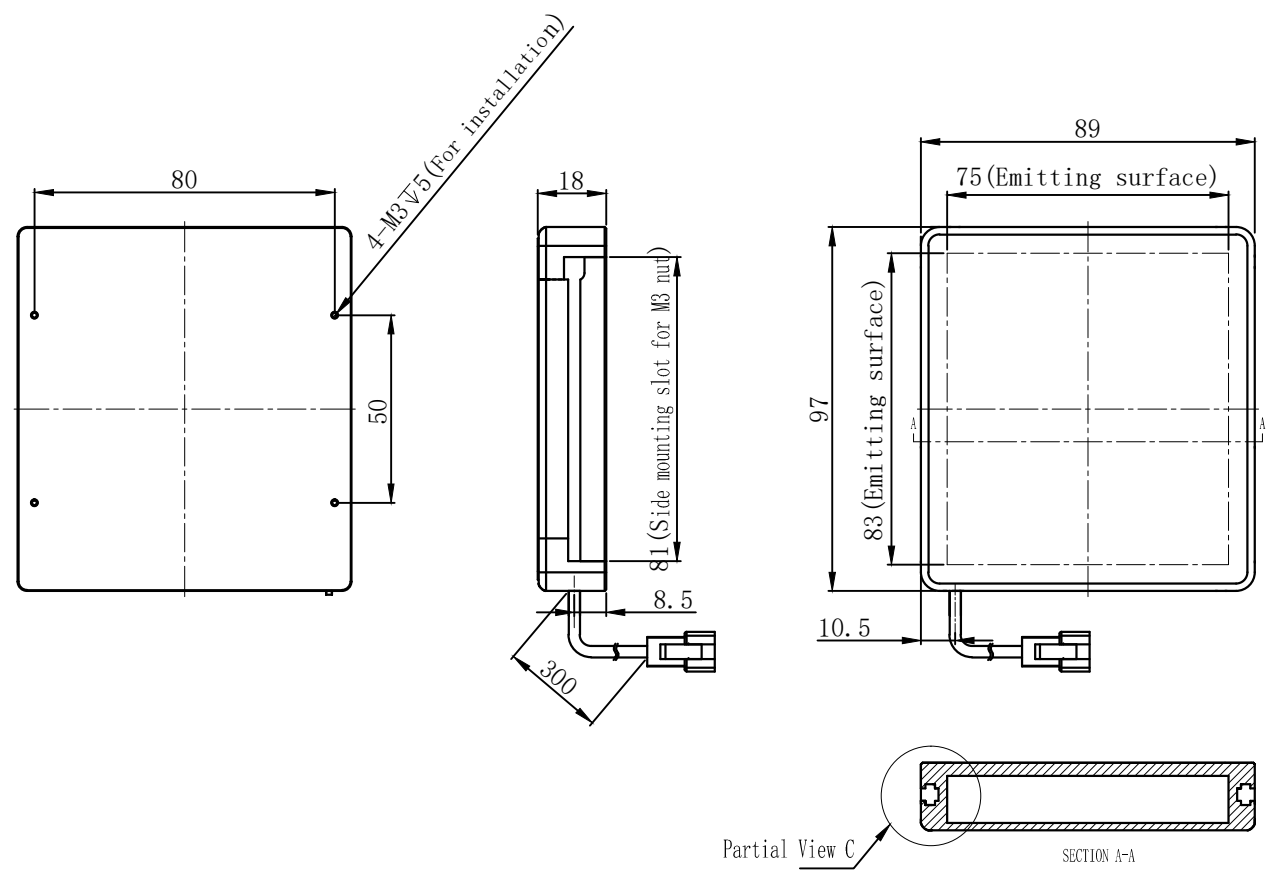
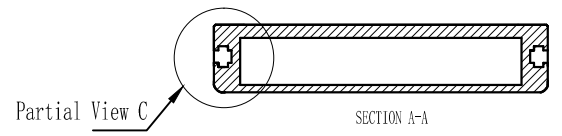

Product Installation Dimensions					Design	成忠波		2017.07.09		wordop® 沃德普	
Input Voltage	Power				Approve						
	R	W/G/B	IR	UV	Weight	View Direction	Ratio	Unit	Name	Bottom-Irradiation Backlights	
24V	5.5W	5.1W			180g		1:2	mm	Model	FQ2-83X75	