

JST-SMR-03V-B

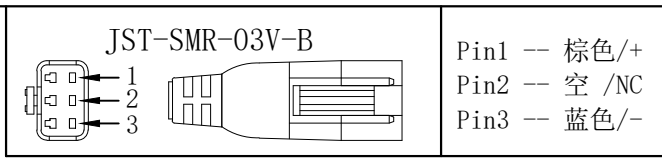

Pin1 -- 棕色/+  
Pin2 -- 空 /NC  
Pin3 -- 蓝色/-

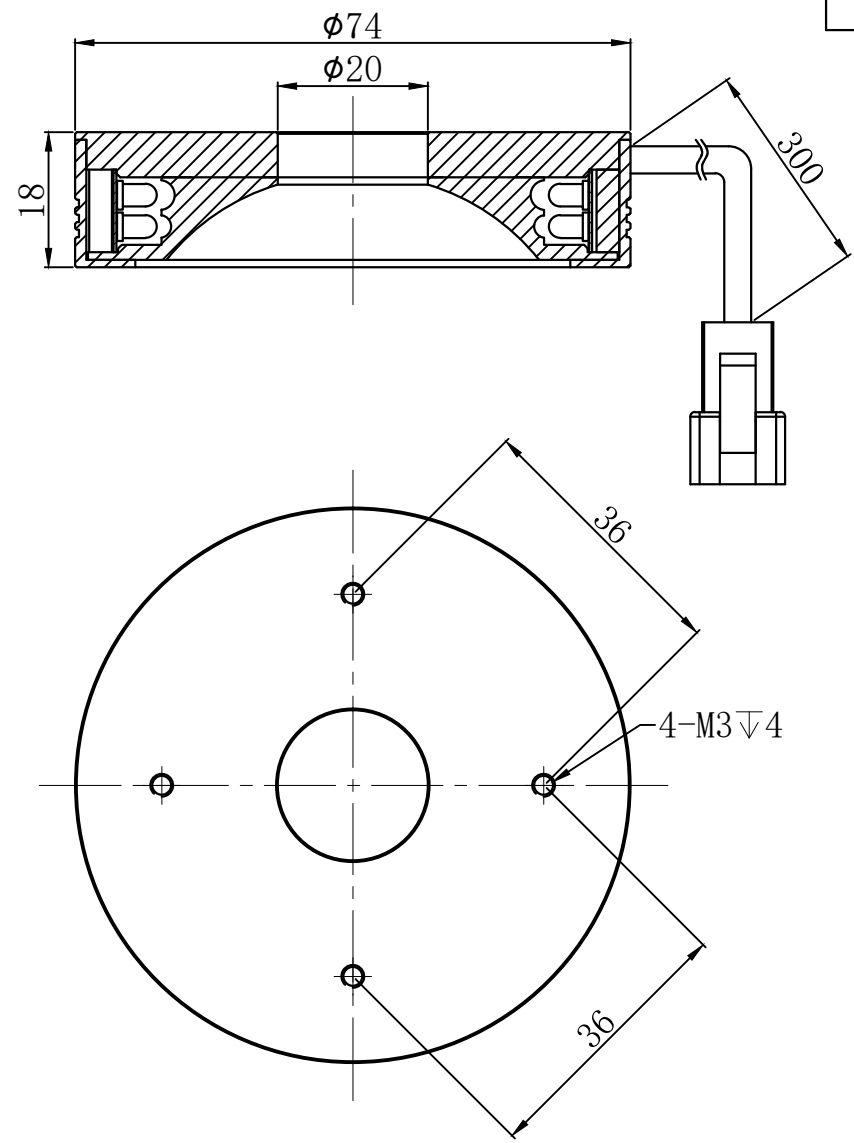
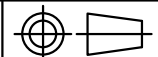

Product Installation Dimensions					Design	成忠波		2017.06.09		wordop® 沃德普	
Input Voltage	Power				Approve						
	R	W/G/B	IR	UV	Weight	View Direction	Ratio	Unit	Name	Diffused High Angle Ring Lights	
24V	3.6W	6.3W			110g		1:1	mm	Model	FGR2-74	