

Pin1 -- 棕色/+
 Pin2 -- 空 /NC
 Pin3 -- 蓝色/-

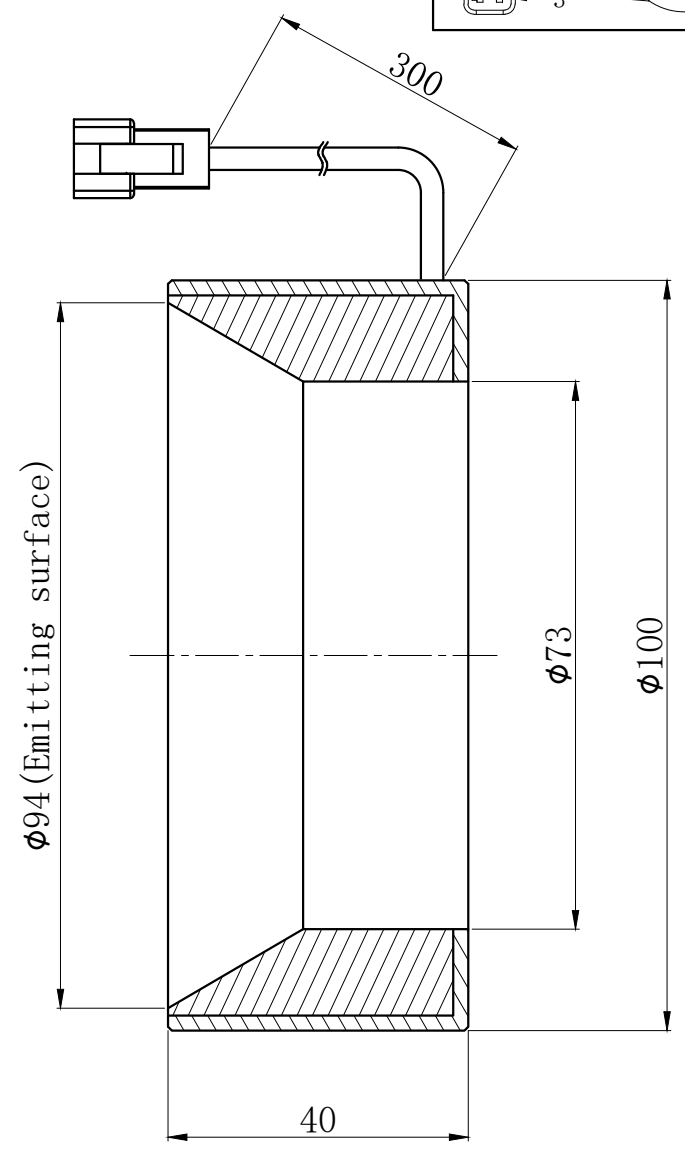
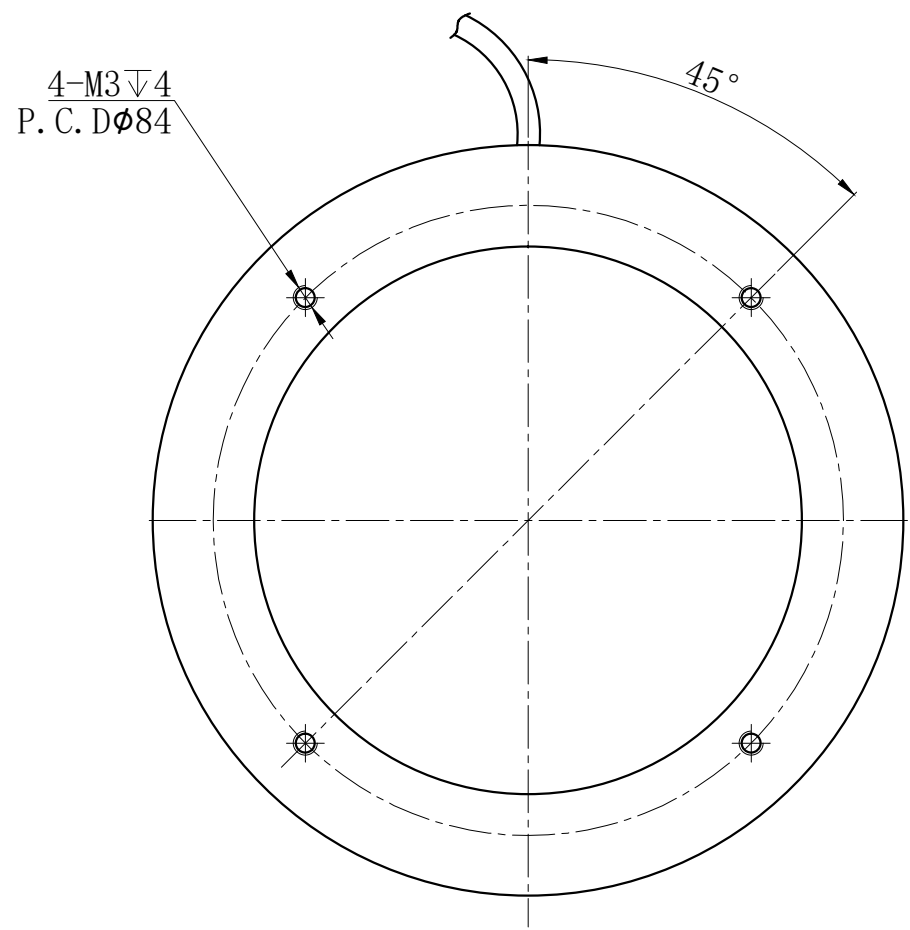

Product Installation Dimensions					Design	成忠波		2017.07.09		wordop® 沃德普	
Input Voltage	Power				Approve						
	R	W/G/B	IR	UV	Weight	View Direction	Ratio	Unit	Name	Diffused Low Angle Ring Lights	
24V	4.9W	7.8W			210g		1:1	mm	Model	FLR-100	