

LTS-LFR180

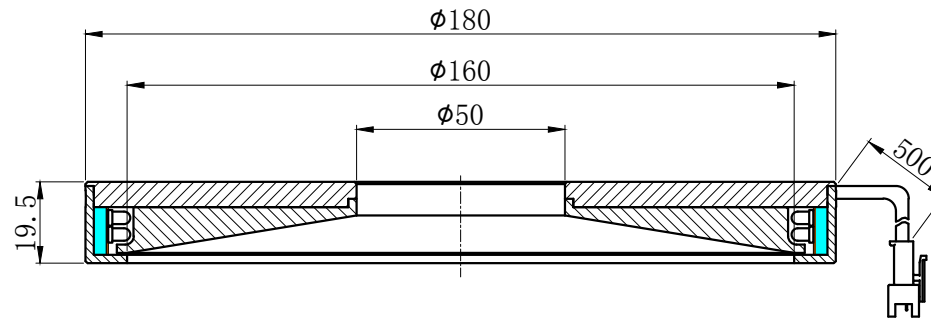

产品型号	LTS-LFR180
LED发光色	W(白)
输入电压	DC 24V(max)
消耗功率	/
电缆极性	1:+、2:NC、3:-

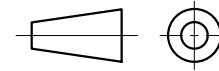